

FITTING INSTRUCTION

Clamp mark in acc. with		Cables joining
ISO	PN	
1	L	Left directional lights
2	+	Rear fog lights
3	31	Ground
4	R	Right directional lights
5	58R	Right side parking lights
6	54	Stoplights
7	58L	Left side parking lights

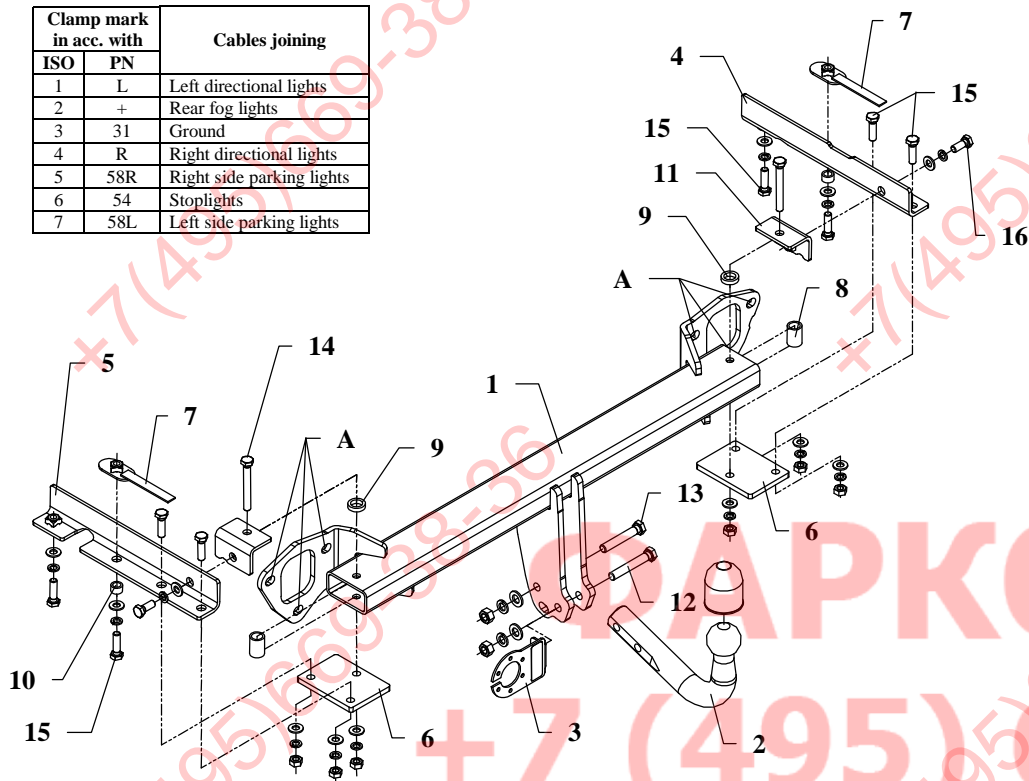

This towing hitch is designed to assembly in following cars:
SUBARU FORESTER, produced since 2008, catalogue no. **SU45** and is prepared to tow trailers max total weight **2000 kg** and max vertical mass **80 kg**.

From manufacturer

Thank you for buying our product. Their reliability has been confirmed in many tests. Reliability of towing hitch depends also on correct assembly and right operation. For this reasons we kindly ask to read carefully this instruction and apply to hints.

The towing hitch should be install in points described by a car producer.

The instruction of the assembly

1. Disassemble the bumper with the metal reinforcement. The reinforcement will not be assembled again.
2. Fix loosely the main bar of the towing hitch (pos. 1) in places after dismantled reinforcement of the bumper (in points A). Use the original nuts.
3. Fix loosely elements (pos. 6 and 11) to the main bar (pos. 1) using bolts M10x80mm (pos. 14) as showed on the drawing. Use distance sleeves (pos. 8 and 9).
4. Slip side brackets (pos. 4 and 5) to chassis members through large holes of the bar's brackets and fix them from the bottom using bolts M10x35mm (pos. 15). Use distance sleeves (pos. 10) as showed on the drawing.
5. Fix side brackets with elements (pos. 6 and 11) using bolts M10x35mm (pos 15) and M10x25mm (pos. 16) as showed on the drawing.
6. Underneath the bumper, in its axis, cut out the fragment: the width 55mm and depths 80mm.
7. Install the bumper and fix tow ball (pos. 2) using bolt M12x75mm (pos. 12) and M12x70mm (pos. 13). With bolt M12x75mm fix also a socket plate (pos. 3). See figure 1.
8. Tighten all bolts according to the torque shown in the table.
9. Connect electric wires of 7-poles socket according to the instruction of the car. (Recommend to make at authorized service station).
10. Complete paint layer damaged during installation.

Torque settings for nuts and bolts (8,8):	
M 8 - 25 Nm	M 10 - 55 Nm
M 12 - 85 Nm	M 14 - 135 Nm











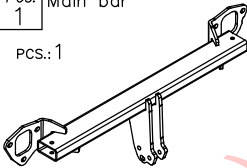
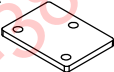
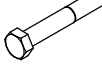

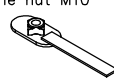
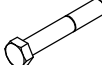



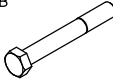

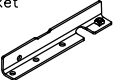

NOTE

After install the towing hitch you should get adequate note in registration book (at authorised service station). The car should be equipped with:

- Indicators
- Tow mirrors

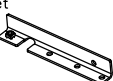
After 1000km check all bolts and nuts. The ball of towing hitch must be always kept clear and conserve with a grease.

Towing hitch accessories:

Pos. 1 Main bar PCS.: 1	Pos. 6 Fish-plate PCS.: 2	Pos. 12 Bolt 8,8 B M12x75mm PCS.: 1	Pos. 18 Nut 8 B M10 PCS.: 6
			
	Pos. 7 Jlb with the nut M10 PCS.: 2	Pos. 13 Bolt 8,8 B M12x70mm PCS.: 1	Pos. 19 Plain washer ø12mm PCS.: 2
			
Pos. 2 Tow ball PCS.: 1	Pos. 8 Distance sleeve ø21.3x2.65mm L=30mm PCS.: 2	Pos. 14 Bolt 8,8 B M10x80 PCS.: 2	Pos. 20 Plain washer ø10mm PCS.: 12
			
Pos. 3 Socket plate PCS.: 1	Pos. 9 Distance sleeve ø25xø4mm L=6mm PCS.: 2	Pos. 15 Bolt 8,8 B M10x35mm PCS.: 8	Pos. 21 Spring washer ø12mm PCS.: 2
			
Pos. 4 Right bracket PCS.: 1	Pos. 10 Distance sleeve ø17x2.65mm L=10mm PCS.: 2	Pos. 16 Bolt 8,8 B M10x25mm PCS.: 2	Pos. 22 Spring washer ø10mm PCS.: 12
			
Pos. 5 Left bracket PCS.: 1	Pos. 11 Angle fish-plate PCS.: 2	Pos. 17 Nut 8 B M12 PCS.: 2	Pos. 23 Ball cover PCS.: 1
			



PPUH AUTO-HAK S.J.

Produkcja Zaczepów Kulowych
Henryk & Zbigniew Nejman
76-200 SŁUPSK ul. Stoleczna 16K
tel/fax (059) 8-414-414; 8-414-413
E-mail: office@autohak.com.pl
www.autohak.com.pl

Towing hitch (without electrical set)

Class: **A50-X** Cat. no. **SU45**

Designed for:

Manufacturer: **SUBARU**

Model: **FORESTER**

produced since 2008

Technical data:

D-value: 10,0 kN

maximum trailer weight: **2000 kg**

maximum vertical cup mass: **80 kg**

Approval number according to Directive 94/20/EC: **e20*94/20*0698*00**

+7 (495) 669-38-36

Foreword

This towing hitch is designed according to rules of safety traffic regulations. The towing hitch is a safety component and can be install only by qualified personnel. Any alteration or conversion of the towing hitch is prohibited and would lead to cancellation of design certification. Remove insulating compound and underseal from vehicle (if present) in the area of the matting surfaces of the towing hitch. The vehicle manufacturer's specifications regarding trailer mass and max. vertical cup mass are decisive for driving whereat values for the towing hitch cannot be exceeded.

D-value formula:

$$\frac{\text{Max trailer weight [kg]} \times \text{Max vehicle weight [kg]}}{\text{Max trailer weight [kg]} + \text{Max vehicle weight [kg]}} \times \frac{9,81}{1000} = D \text{ [kN]}$$